






## PRINTING CHARACTERS AND SYMBOLS

Throughout this manual, the following symbols and printing characters are used to facilitate reading:

|   |  |
|---|--|
|  | Indicates the operations which need proper care                  |
|  | Indicates prohibition  |
|  | Indicates a possibility of danger for the operators              |
|  | Indicates the direction of access for motor vehicles to the lift |
| <b>BOLD<br/>TYPE</b>  | Important information  |

|   |  |
|---|--|
|  | <b>WARNING: before operating the lift and carrying out any adjustment, read carefully chapter 7 “installation” where all proper operations for a better functioning of the lift are shown.</b> |
|---|--|

## CONTENTS

|           |                                       |           |
|-----------|---------------------------------------|-----------|
| <b>1</b>  | <b>GENERAL INFORMATION</b>            | <b>4</b>  |
| <b>2</b>  | <b>PRODUCT IDENTIFICATION</b>         | <b>6</b>  |
| <b>3</b>  | <b>PACKING, TRANSPORT AND STORAGE</b> | <b>7</b>  |
| <b>4</b>  | <b>PRODUCT DESCRIPTION</b>            | <b>8</b>  |
| <b>5</b>  | <b>TECHNICAL SPECIFICATION</b>        | <b>9</b>  |
| <b>6</b>  | <b>SAFETY</b>                         | <b>14</b> |
| <b>7</b>  | <b>INSTALLATION</b>                   | <b>17</b> |
| <b>8</b>  | <b>OPERATION AND USE</b>              | <b>20</b> |
| <b>9</b>  | <b>MAINTENANCE</b>                    | <b>22</b> |
| <b>10</b> | <b>TROUBLESHOOTING</b>                | <b>23</b> |

## CHAPTER 1 – GENERAL INFORMATION

This chapter contains warning instructions to operate the lift properly and prevent injury to operators or objects.

This manual has been written to be used by shop technicians in charge of the lift (operator) and routine maintenance technician (maintenance operator).

The operating instructions are considered to be an integral part of the machine and must remain with it for its whole useful life.

Read every section of this manual carefully before operating the lift and unpacking it since it gives helpful information about:

- SAFETY OF PEOPLE
- SAFETY OF THE LIFT
- SAFETY OF LIFTED VEHICLES

The company is not liable for possible problems, damage, accidents, etc. resulting from failure to follow the instructions contained in this manual.

Only skilled technicians of AUTHORISED DEALERS or SERVICE CENTRES AUTHORISED by the manufacturer shall be allowed to carry out lifting, transport, assembling, installation, adjustment, calibration, settings, extraordinary maintenance, repairs, overhauling and dismantling of the lift.

**THE MANUFACTURER IS NOT RESPONSIBLE FOR POSSIBLE DAMAGE TO PEOPLE, VEHICLES OR OBJECTS IF SAID OPERATIONS ARE CARRIED OUT BY UNAUTHORIZED PERSONNEL OR THE LIFT IS IMPROPERLY USED.**

Any use of the machine made by operators who are not familiar with the instructions and procedures contained herein shall be forbidden.

### 1.1 MANUAL KEEPING

For a proper use of this manual, the following is recommended:

- keep the manual near the lift, in an easily accessible place.
- keep the manual in an area protected from the damp.
- use this manual properly without damaging it.
- Any use of the machine made by operators who are not familiar with the instructions and procedures contained herein shall be forbidden.

This manual is an integral part of the lift: it shall be given to the new owner if and when the lift is resold.


### 1.2 OBLIGATION IN CASE OF MALFUNCTION




**In case of machine malfunction, follow the instructions contained in the following chapters.**


### 1.3 CAUTIONS FOR THE SAFETY OF THE OPERATOR


Operators must not be under the influence of sedatives, drugs or alcohol when operating the machine.

|   |  |
|---|--|
|  | <b>Before operating the lift, operators must be familiar with the position and function of all controls, as well as with the machine features shown in the chapter “Operation and use”</b> |
|---|--|

### 1.4 WARNINGS

|   |   |
|---|---|
|  | <b>Unauthorized changes and/or modifications to the machine relieve the manufacturer of any liability for possible damages to objects or people. Do not remove or make inoperative the safety devices, this would cause a violation of safety at work laws and regulations.</b> |
|---|---|

|   |   |
|---|---|
|  | <b>Any other use which differs from that provided for by the manufacturer of the machine is strictly forbidden.</b> |
|---|---|

|   |   |
|---|---|
|  | <b>The use of non genuine parts may cause damage to people or objects</b> |
|---|---|

### DECLARATION OF WARRANTY AND LIMITATION OF LIABILITY

The manufacturer has paid proper attention to the preparation of this manual. However, nothing contained herein modifies or alters, in any way, the terms and conditions of manufacturer agreement by which this lift was acquired, nor increase, in any way, manufacturer’s liability to the customer.

#### TO THE READER

Every effort has been made to ensure that the information contained in this manual is correct, complete and up-to date. The manufacturer is not liable for any mistakes made when drawing up this manual and reserves the right to make any changes due the development of the product, at any time.

## CHAPTER 2 – PRODUCT IDENTIFICATION

The identification data of the machine are shown in the label placed on the control unit.

|                        |       |
|------------------------|-------|
| LOGO                   |       |
| Type:                  | ..... |
| Model:                 | ..... |
| Serial Number:         | ..... |
| Year of manufacturing: | ..... |
| Capacity:              | ..... |
| Voltage:               | ..... |
| Power:                 | ..... |



**Use the above data both to order spare parts and when getting in touch with the manufacturer (inquiry). The removal of this label is strictly forbidden.**

Machines may be updated or slightly modified from an aesthetic point of view and, as a consequence, they may present different features from these shown, this without prejudicing what has been described herein.

### 2.1 WARRANTY CERTIFICATE

The warranty is valid for a period of 12 months starting from the date of the purchase invoice. The warranty will come immediately to an end when unauthorized modifications to the machine or parts of it are carried out. The presence of defects in workmanship must be verified by the Manufacturer's personnel in charge.

### 2.2 TECHNICAL SERVICING

For all servicing and maintenance operations not specified or shown in these instructions, contact your Dealer where the machine has been bought or the Manufacturer's Commercial Department. Only skilled personnel who are familiar with the lift and this manual shall be allowed to carry out packing, lifting, handling, transport and unpacking operations.

## CHAPTER 3 - PACKING, TRANSPORT AND STORAGE

### 3.1 PACKING

The packing of the lift is delivered in following components:

- N. 1 base units packed in a steel frame, wrapped up in non-scratch material
- N. 1 portable power unit packed in a plywood box, including N. 4 rubber pads

(If requested, optional accessories are available to satisfy each customer's requirements).

The average weight of the package is 600kg.

### 3.2 LIFTING AND HANDLING

When loading/unloading or transporting the equipment to the site, be sure to use suitable loading (e.g. cranes, trucks) and hoisting means. Be sure also to hoist and transport the components securely so that they cannot drop, taking into consideration the package's size, weight and centre of gravity and its fragile parts.



### 3.3 STORAGE AND STACKING OF PACKAGES

Packages must be stored in a covered place, out of direct sunlight and in low humidity, at a temperature between -10°C and +40°C.

Stacking is not recommended: the package's narrow base, as well as its considerable weight and size make it difficult and hazardous.

### 3.4 DELIVERY AND CHECK OF PACKAGES

When the lift is delivered, check for possible damages due to transport and storage; verify that what is specified in the manufacturer's confirmation of order is included. In case of damage in transit, the customer must immediately inform the carrier of the problem.

Packages must be opened paying attention not to cause damage to people (keep a safe distance when opening straps) and parts of the lift (be careful the objects do not drop from the package when opening).

## CHAPTER 4 - PRODUCT DESCRIPTION

### LIFT DESCRIPTION (Ref. Figure 1)

This portable lift has been designed for the lifting of motor-vehicles for maintenance.

The maximum lifting weight is as specified on the serial plate.

All mechanical frames, such as platforms, extensions, base frames and arms have been built in steel plate to make the frame stiff and strong while keeping a low weight

The electro hydraulic operation is described in detail in chapter 8.

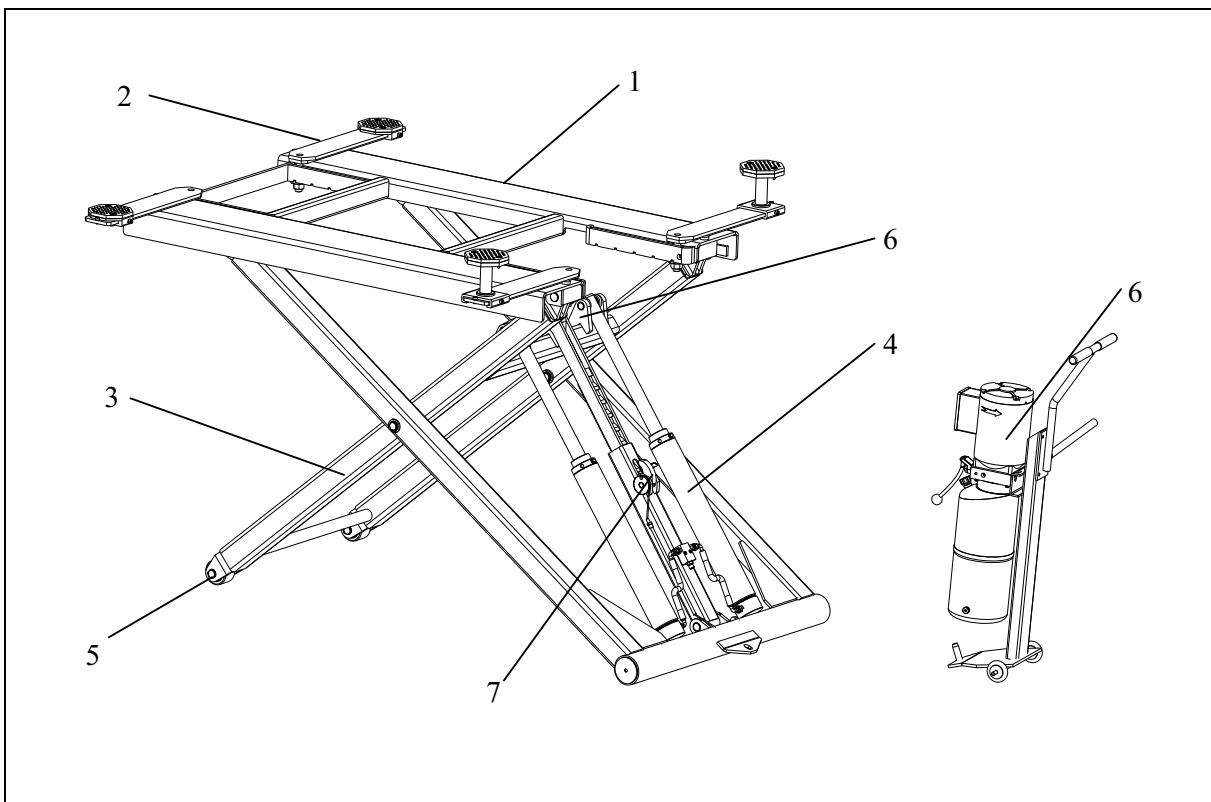
This chapter describes the lift's principal elements, allowing the user to be familiar with the machine.

As shown in figure 1, the lift is composed of a frame (1), N.4 lifting arms (2), N.2 pair of scissors (3) and N.2 cylinders (4), can be movable by means of wheels (5).

The lifting and lowering motion is carried out by operation of the lifting button and the lowering lever on the control unit (6).

The mechanical safety (7) operating manually is installed between 2 cylinders.

Figure 1 – LIFT



## CHAPTER 5 - TECHNICAL SPECIFICATION

### 5.1 SIZE AND MAIN FEATURES (Ref. Figure 2)

|                                  |                 |
|----------------------------------|-----------------|
| <b>CAPACITY</b>                  | <b>6000 LBS</b> |
| Max. lifting height              | 1300mm          |
| Min. lowered height              | 152mm           |
| Max. length between lifting pads | 1748mm          |
| Max. width between lifting pads  | 1379mm          |
| Lifting time                     | 60 s            |
| Lowering time                    | 40 s            |
| Noise level                      | 80 dB(A)/1m     |
| Working temperature              | -10 °C ÷ 40 °C  |
| Average weight of package        | 500g            |

### 5.2 ELECTRIC MOTOR

|                      |          |
|----------------------|----------|
| Voltage              | 110V-1Ph |
| Power                | 2.2 KW   |
| N° Poles             | 4        |
| Speed                | 1700 rpm |
| Motor enclosure type | B14      |
| Insulation class     | IP 54    |

Motor connection must be carried out referring to the attached wiring diagrams (figure 5).

The motor direction of rotation is shown in the label placed on the motor.

Before use of the lift, make sure to check if the motor specification shown in the nameplate of the motor conforms to the local electric supply.

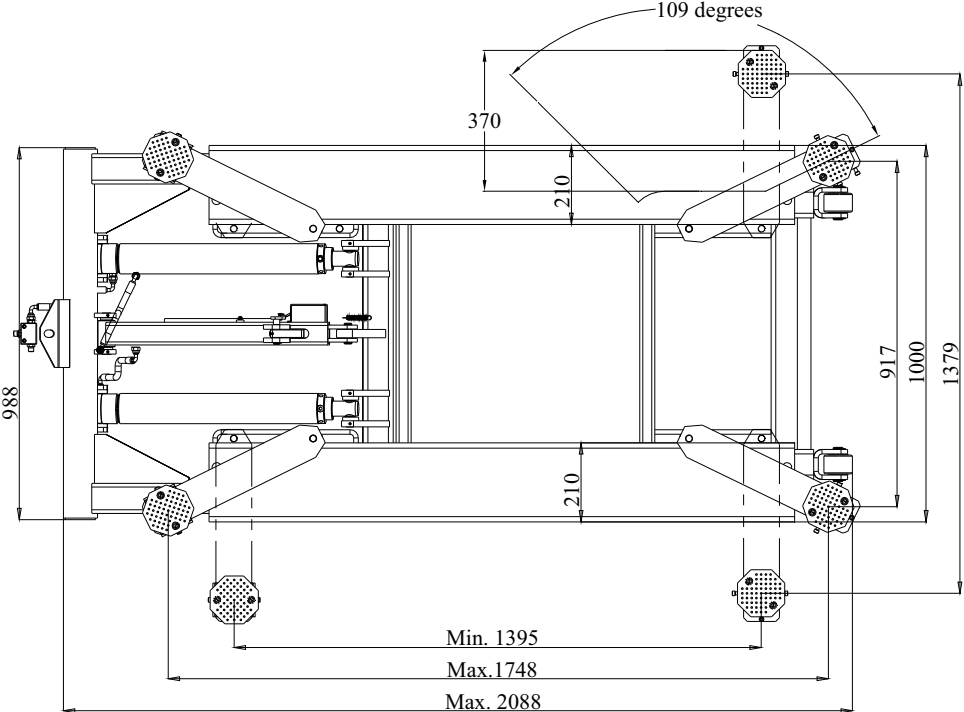
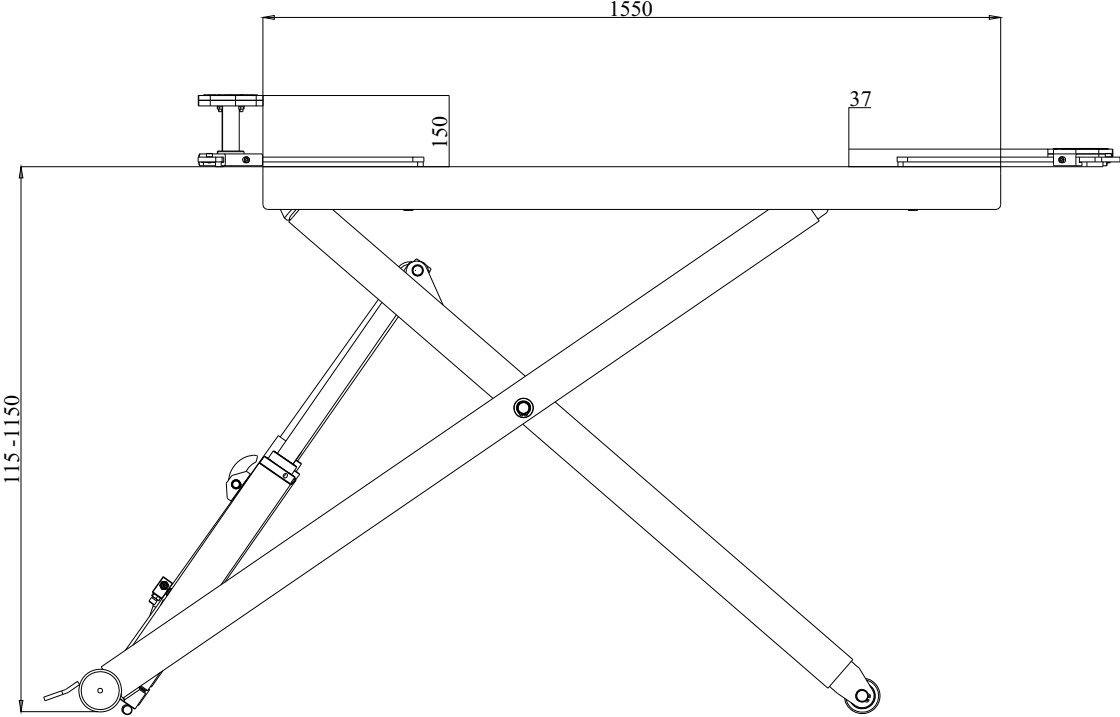
If there is over 10% fluctuation on the electrical power supply, it is suggested to use the voltage stabilizer to protect the electrical components and system from overloading.

### 5.3 PUMP

|                             |                        |
|-----------------------------|------------------------|
| Type                        | Gear                   |
| Flow rate                   | 2.1 cm <sup>3</sup> /g |
| Continuous working pressure | 230 bar – 250bar       |

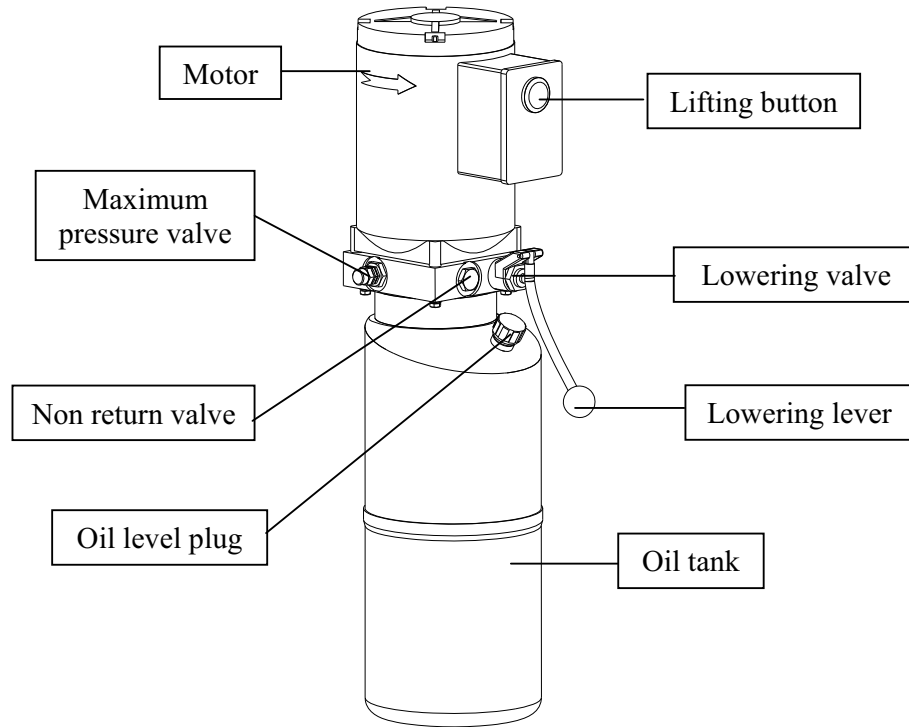


Figure 2 - LAYOUT



## 5.4 HYDRUALIC POWER UNIT

Figure 3 – HYDRAULIC POWER UNIT



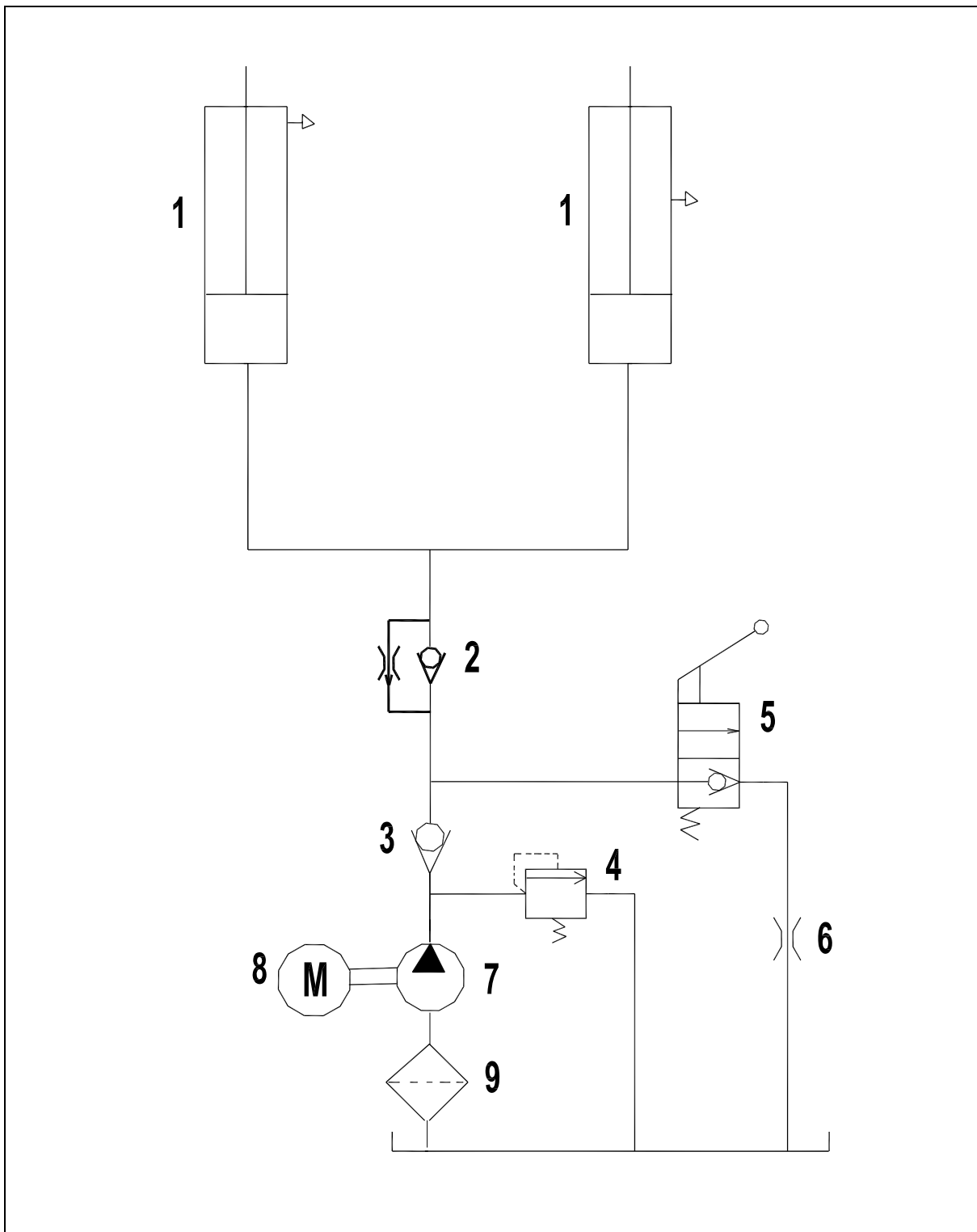
## 5.5 OIL

Use wear proof oil for hydraulic drive, in conformity with *ISO 6743/4* rules (HM class). The oil with features similar to those shown in the table is recommended.

| TEST STANDARDS | FEATURES              | VALUE        |
|----------------|-----------------------|--------------|
| ASTM D 1298    | Density 20°C          | 0.8 kg/l     |
| ASTM D 445     | Viscosity 40°C        | 32 cSt       |
| ASTM D 445     | Viscosity 100°C       | 5.43 cSt     |
| ASTM D 2270    | Viscosity index       | 104 N°       |
| ASTM D 97      | Pour point            | ~ 30 °C      |
| ASTM D 92      | Flash point           | 215 °C       |
| ASTM D 644     | Neutralization number | 0.5 mg KOH/g |

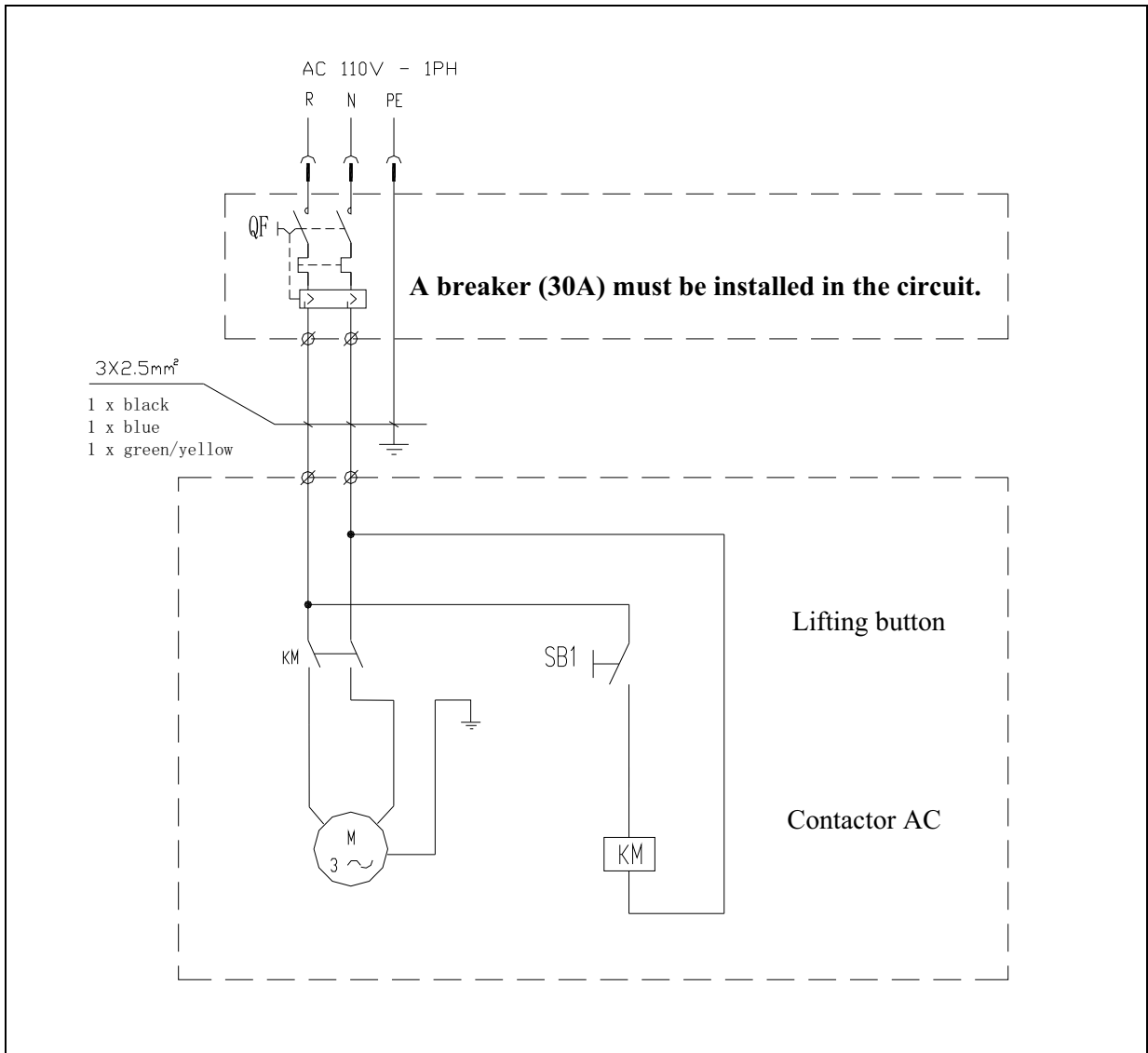
|   |   |
|---|---|
|  | <b>CHANGE HYDRAULIC OIL AT 1 YEAR INTERVALS</b> |
|---|---|

Figure 4 – HYDRAULIC PLAN




|   |                        |   |                 |
|---|------------------------|---|-----------------|
| 1 | Hydraulic cylinder     | 6 | Flow restrictor |
| 2 | Safety valve           | 7 | Gear pump       |
| 3 | Non return valve       | 8 | Motor           |
| 4 | Maximum pressure valve | 9 | Oil filter      |
| 5 | Manual lowering valve  |   |                 |

Figure 5 – ELECTRICAL WIRING DIAGRAM (110V -1PH)




## CHAPTER 6 – SAFETY

Read this chapter carefully and completely because it contains important information for the safety of the operator and the person in charge of maintenance.

|   |  |
|---|--|
|  | <p><b>The lift has been designed and built for lifting vehicles and making them stand above level in a closed area. Any other use is forbidden.</b></p> <p><b>The manufacturer is not liable for possible damages to people, vehicles or objects resulting from an improper or unauthorized use of the lift.</b></p> |
|---|--|

For operator and people safety, a safety area at least 1m free away from the lift must be vacated during lifting and lowering. The lift must be operated only from the operator's control site in this safety area.

Operator's presence under the vehicle, during working, is only admitted when the vehicle is lifted and platforms are not running.

|   |  |
|---|--|
|  | <p><b>Never use the lift when safety devices are off-line. People, the lift and the vehicles lifted can be seriously damaged if these instructions are not followed.</b></p> |
|---|--|

### 6.1 GENERAL WARNINGS

The operator and the person in charge of maintenance must follow accident-prevention laws and rules in force in the country where the lift is installed


They also must carry out the following:

- neither remove nor disconnect hydraulic, electric or other safety devices;
- carefully follow the safety indications applied on the machine and included in the manual;
- observe the safety area during lifting;
- be sure the motor of the vehicle is off, the gear engaged and the parking brake put on;
- be sure only authorized vehicles are lifted without exceeding the maximum lifting capacity;
- Verify that no one is on the platforms during lifting or standing.

### 6.2 RISKS DURING VEHICLE LIFTING

To avoid overloading and possible breaking, the following safety devices have been used:

- a maximum pressure valve placed inside the hydraulic unit to prevent excessive weight.
- a special design of the hydraulic system, in case of pipeline failure, to prevent sudden lift lowering..

|   |   |
|---|---|
|  | <p><b>The maximum pressure valve has been preset by the manufacturer to a proper pressure. DO NOT try to adjust it to overrun the rated lifting capacity.</b></p> |
|---|---|

### 6.3 RISKS FOR PEOPLE

All risks the personnel could run, due to an improper use of the lift, are described in this section.

## 6.4 PERSONNEL CRUSHING RISKS

During lowering of runways and vehicles, personnel must not be within the area covered by the lowering trajectory. The operator must be sure no one is in danger before operating the lift.



Fig. 6a

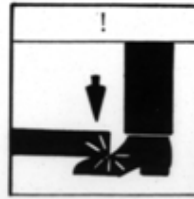


Fig. 6b



Fig. 6c

## 6.5 BUMPING RISK

When the lift is stopped at relatively low height for working, the risk of bumping against projecting parts occurs.



Fig. 7

## 6.6 RISK OF THE VEHICLE FALLING FROM THE LIFT

Vehicle falling from the lift can be caused when the vehicle is improperly placed on platforms, and when its dimensions are incompatible with the lift or by excessive movement of the vehicle. In this case, keep immediately away from the working area.



Fig. 8a



Fig. 8b

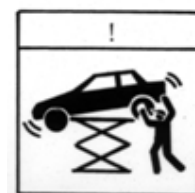



Fig. 8c

## 6.7 SLIPPING RISKS

The risk of slipping can be caused by oil or dirt on the floor near the lift.



Fig. 9

|   |  |
|---|--|
|  | <b>Keep the area under and around the lift clean. Remove all oil spills.</b> |
|---|--|

## 6.8 ELECTROCUTION RISKS

Avoid use of water, steam, and solvent, varnish jets in the lift area where electric cables are placed

and, in particular, next to the electric panel.

## 6.9 RISKS RESULTING FROM IMPROPER LIGHTING

Make sure all areas next to the lift are well and uniformly lit, according to local regulations.

## 6.10 RISKS OF BREAKING COMPONENT DURING OPERATION

Materials and procedures, suitable for the designed parameters of the lift, have been used by the manufacturer to build a safe and reliable product. Operate the lift only for the use it has been designed for and follow the maintenance schedule shown in the chapter “Maintenance”.



Fig. 10

## 6.11 RISKS FOR UNAUTHORIZED USES

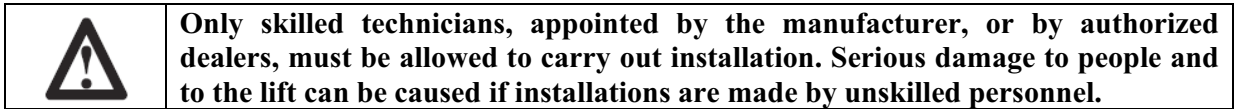
The presence of unauthorized persons next to the lift and on the platforms is strictly forbidden during lifting as well as when the vehicle has been already lifted



Fig. 11

|   |   |
|---|---|
|  | <p><b>Any use of the lift other than that herein specified can cause serious accidents to people in close proximity of the machine.</b></p> |
|---|---|

## CHAPTER 7 – INSTALLATION



### 7.1 CHECKING FOR PLACE SUITABILITY

The lift has been designed to be used in covered and sheltered places free of overhead obstructions. The working place must not be next to washing areas, painting workbenches, solvent or varnish deposits. The relevant standards of the local Health and Safety at Work regulations, for instance, with respect to minimum distance to wall or other equipment, escapes and the like, must be observed.

All areas next to the lift must be well and uniformly lit.

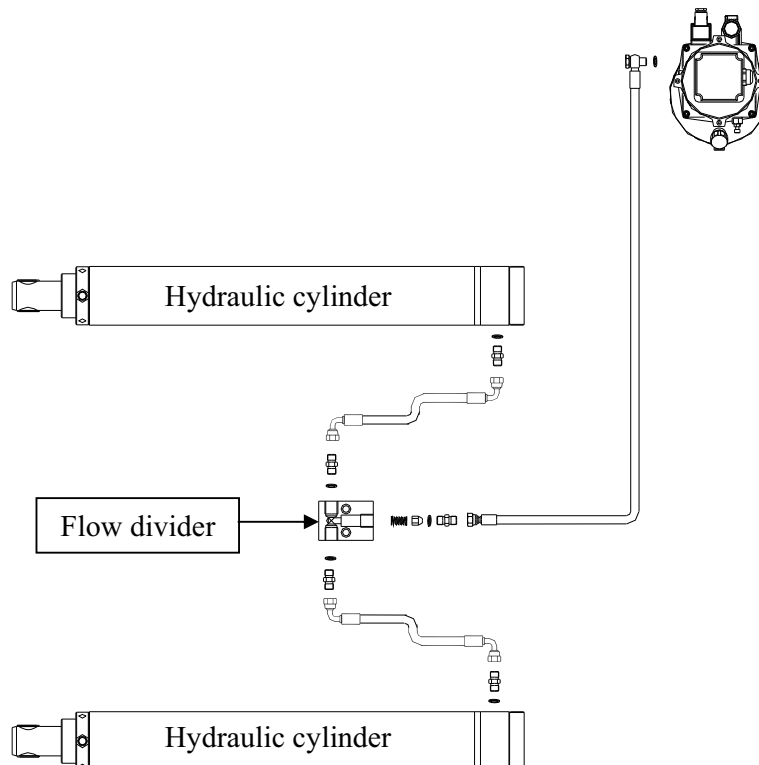
### 7.2 CONCRETE SURFACE

The lift must be placed on the concrete surface sufficiently resistant. The surface must be suitable for bearing maximum stress values, also in unfavorable working conditions. The surface must be perfectly leveled.

### 7.3 HYDRAULIC SYSTEM CONNECTION


- Connect hydraulic hoses referring to the figure 12;
- Tighten fittings thoroughly.

Figure 12 – HYDRAULIC CONNECTIONS





## 7.4 MAKE THE ELECTRICAL HOOKUP TO HYDRAULIC POWER UNIT


|   |   |
|---|---|
|  | <p><b>The hookup work must be carried out by a qualified electrician.</b></p> <p><b>Make sure that the power supply is right.</b></p> <p><b>Make sure the connection of the phases is right. Improper electrical hook-up can damage motor and will not be covered under warranty.</b></p> <p><b>DO NOT run the hydraulic unit with no oil. Damage to pump can occur.</b></p> <p><b>The power unit must be kept dry.</b></p> |
|---|---|

- Fix the control panel onto the power-side column using the included screws.
- Make the electric hookup to the power unit referring to the attached the electric diagram figure 5 using the included electric cable.
- Make sure the connection of the phases is right and lift is grounded.

## 7.5 START

- Make sure all pins and bolts to insure proper mounting
- Make sure the electrical system feeding voltage is equal to that specified in the nameplate on the motor
- Make sure the electric connections are in compliant with diagrams figure 5
- Make sure no leakage or blow-up in hydraulic line
- Make sure the working area is free from people and objects
- Grease sliding seats of blocks placed under platforms and on bases
- Pour oil in the tank (*about 5 liters more than one time*)
- Verify that the control unit is powered
- Verify that the motor direction of rotation is that shown on the label by pushing the lifting button. **IF MOTOR GETS HOT OR SOUNDS PECULIAR, STOP IMMEDIATELY AND RECHECK THE ELECTRIC CONNECTIONS**

## 7.6 BLEEDING

|   |   |
|---|---|
|  | <p><b>Do not install the maximum working height limit switch before bleeding the hydraulic line.</b></p> <p><b>During this procedure, DO NOT attempt to raise the lift with any load.</b></p> |
|---|---|

- Raising the lift slowly by pressing the lifting button until cylinders bottom out and the lift stops. **DO NOT** continue pressing button after lift reaches full height. Damage to motor can occur if continued.
- Lower the lift completely by pressing the lowering lever.
- Repeat raise and lower the lift completely at least 5 times to equalize the oil pressure in each cylinder.

## 7.7 CHECKS LESS LOAD



**During this procedure, observe all operating components and check for proper installation and adjustment. DO NOT attempt to raise vehicle until a thorough operation check has been completed.**

Carry out two or three complete cycles of lowering and lifting and check:

- the safety devices for proper operation
- proper oil level in the tank
- no leakage and blow-by in hydraulic line
- cylinder for proper operation
- the lift for reaching its maximum height

## 7.8 CHECKING WITH LOAD




**WARNING: please follow carefully the instructions in the coming paragraph for avoiding damages on the lift.**

Carry out two or three complete cycles of lowering and lifting and check:

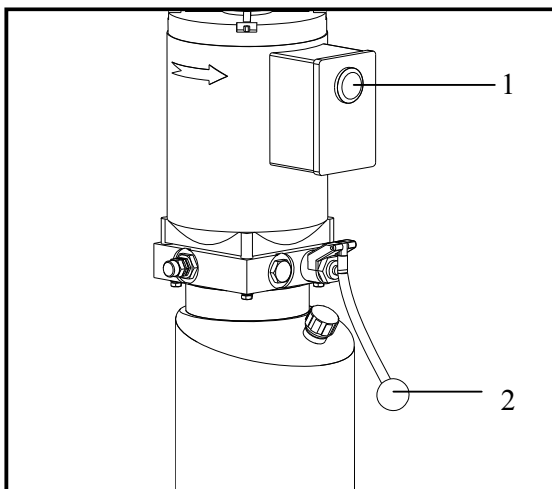
- Repeat the 7.7 section
- Check no strange noise during lifting and lowering

## CHAPTER 8 - OPERATION AND USE

|   |   |
|---|---|
|  | <p><b>Never operate the lift with any person or equipment below.</b></p> <p><b>Never exceed the rate lifting capacity.</b></p> <p><b>Always ensure that the lift safety is locked before any attempt is made to work on or near the vehicle.</b></p> <p><b>Do not permit the power unit to get wet!</b></p> |
|---|---|

### 8.1 CONTROLS

Figure 13 - CONTROLS



Controls for operating the lift are:

#### **LIFTING BUTTON (1)**

- When pressed, the motor is powered to operate the hydraulic circuit to raise the lift.

#### **LOWERING LEVER (2)**

- When pressed, the hydraulic fluid is released from the cylinder to the oil tank: the lift starts to descend.

#### **SAFETY RELEASE LEVER (3)**

- When pressed, the mechanical safety is released.

### 8.2 TO RAISE THE LIFT


- Drive the vehicle at the centre of the lift. Check to make sure that the vehicle is secured.
- Position the lifting arms and adaptors in the proper position indicated by the vehicle manufacturer;
- Press the lifting button to raise the vehicle;
- To rest the lift in standing position at the desired height by releasing the lifting button;

- Press the lowering lever to lower the lift to engage the mechanical safety;
- Always ensure that the lift rests on the safety before any attempt is made to work on or near the vehicle.

### **8.3 TO LOWER THE LIFT**

- Be sure the safety area is free of people and objects;
- Raise the lift a little bit by pushing the lifting button to clear off the safety;
- Release the safety by operating the manual release lever;
- Continue pressing the lowering lever until the lift is lowered completely.

## CHAPTER 9 - MAINTENANCE


|   |  |
|---|--|
|  | <b>Only trained personnel who knows how the lift works, must be allowed to service the lift.</b> |
|---|--|

To service properly the lift, the following has to be carried out:

- use only genuine spare parts as well as equipment suitable for the work required;
- follow the scheduled maintenance and check periods shown in the manual;
- discover the reason for possible failures such as too much noise, overheating, oil blow-by, etc.

Refer to documents supplied by the dealer to carry out maintenance:

- functional drawing of the electric and hydraulic equipment
- exploded views with all data necessary for spare parts ordering
- list of possible faults and relevant solutions.

|   |   |
|---|---|
|  | <b>Before carrying out any maintenance or repair on the lift, disconnect the power supply, padlock the general switch and keep the key in a safe place to prevent unauthorized persons from switching on or operating the lift.</b> |
|---|---|

### 9.1 ORDINARY MAINTENANCE

The lift has to be properly cleaned at least once a month using self-cleaning clothes. Lubricate all pivot pins at least once a week.

|   |  |
|---|--|
|  | <b>The use of water or inflammable liquid is strictly forbidden.</b> |
|---|--|

Be sure the rod of the hydraulic cylinders is always clean and not damaged since this may result in leakage from seals and, as a consequence, in possible malfunctions.

### 9.2 PERIODIC MAINTENANCE

|                 |                   |  |
|-----------------|-------------------|--|
| Every 3 months  | Hydraulic circuit | <ul style="list-style-type: none"> <li>▪ check oil tank level; refill with oil, if needed;</li> <li>▪ check the circuit for oil leakage.</li> <li>▪ check seals for proper conditions and replace them, if necessary;</li> </ul> |
|                 | Foundation bolts  | <ul style="list-style-type: none"> <li>▪ check bolts for proper tightening</li> </ul>  |
|                 | Hydraulic pump    | <ul style="list-style-type: none"> <li>▪ verify that no noise changes take place in the pump when running and check fixing bolts for proper tightening</li> </ul>  |
|                 | Safety system     | <ul style="list-style-type: none"> <li>▪ check safety devices for proper operation</li> </ul>  |
| Every 6 months  | Oil               | <ul style="list-style-type: none"> <li>▪ check oil for contamination or ageing. Contaminated oil is the main reason for failure of valves and shorter life of gears pumps</li> </ul>   |
| Every 12 months | General check     | <ul style="list-style-type: none"> <li>▪ verify that all components and mechanisms are not damaged</li> </ul>  |
|                 | Electrical system | <ul style="list-style-type: none"> <li>▪ a check of the electrical system to verify that motor, limit switch and control panel operate properly must be carried out by skilled electricians</li> </ul>                           |
|                 | Oil               | <ul style="list-style-type: none"> <li>▪ empty the oil tank and change the hydraulic oil</li> </ul>  |

## CHAPTER 10 – TROUBLESHOOTING

A list of possible troubles and solutions is given below

| <b>TROUBLE:</b>  | <b>POSSIBLE CAUSE:</b>                              | <b>SOLUTION:</b>  |
|--|---|---|
|  | The main switch is not turned on                    | Turn the switch on  |
| The lift does not work                                     | There is no power                                   | Check Power on to restore if necessary                                  |
|  | The electrical wires are disconnected               | Reconnect   |
|  | Fuses are blown                                     | Replace   |
| The lift does not raise                                    | The motor direction of rotation is not correct.     | Interchange the two phases on the main switch                           |
|  | The oil in the hydraulic unit is not sufficient.    | Add some hydraulic oil  |
|  | Presences of air in the hydraulic circuit           | Bleed the hydraulic system  |
|  | The UP button is faulty.                            | Check UP button and connection for proper operation. Replace, if needed |
|  | The maximum pressure valve is faulty                | Check and clean if dirty or replace if needed                           |
|  | The lowering valve is faulty.                       | Check and clean if dirty or replace if faulty                           |
|  | The pump filter is dirty.                           | Check and clean if needed.  |
|  | The pump suction is blown                           | Check the seal and replace if needed                                    |
| The platforms are not leveled                              | Oil leakages in hydraulic circuit                   | Check the circuit for any leakage                                       |
| The lift does not lower when the lowering lever is pressed | The lowering valve is faulty.                       | Check and clean if dirty or replace if faulty                           |
| The lift does not lift or lower smoothly                   | Leakages or presences of air into hydraulic circuit | Bleed the hydraulic system  |
|  | The pump filter is dirty.                           | Check and clean if needed.  |
|  | The pump suction is blown                           | Check the seal and replace if needed                                    |